



GolfBoard/GolfBoard PRO

OWNER'S MANUAL

Welcome to GolfBoarding

Thank you for your GolfBoard purchase!

The GolfBoard is going to change the way people experience the game of golf forever. From now on, when golfers “Surf the Earth” from shot-to-shot, they will enjoy golf in a whole new way - we call it GolfBoarding.

Young or old, first time surfer or avid board sports enthusiast, anyone can learn to GolfBoard. Now it's possible to enjoy the unique experience of Surfing the Earth at your local course, or in the convenience of your own back yard. Follow our new user on-boarding procedures, watch our brief safety video, and you will quickly feel like and expert GolfBoarder.

The GolfBoard is environmentally friendly. Built from the ground up specifically for golf course use, we have designed the GolfBoard to meet the demands of even the hilliest golf course. Our military grade engineering and construction ensures high performance and durability.

The first product of its kind, the GolfBoard sets the standard for land-based surfing. With the design influence of blue water surfing icon Laird Hamilton, the GolfBoard is the original, authentic, and only way to ‘Surf the Earth.’

Please take the time to closely familiarize yourself with this Owner’s Manual, as it will help you get the most enjoyment from your new GolfBoard.

Thanks again for your purchase!

–The GolfBoard Team

Table of Contents

TABLE OF CONTENTS	3
1. INTRODUCTION.....	4
1.1. WELCOME	4
1.2. USING THIS MANUAL.....	4
1.3. STAYING UPDATED	4
1.4. ADDITIONAL RESOURCES.....	4
1.5. NOTICES, CAUTIONS, WARNINGS, AND DANGERS.....	5
1.6. ABOUT THIS MANUAL.....	5
1.7. GENERAL INFORMATION	6
1.8. TECHNICAL SPECIFICATIONS AND KEY PRODUCT FEATURES	6
1.9. INCLUDED COMPONENTS.....	9
2. SAFETY INFORMATION	9
2.1. GENERAL SAFETY WARNINGS.....	9
2.2. GENERAL.....	9
2.3. SAFETY VIDEO.....	11
2.4. WARNING LABELS AND PICTOGRAMS	11
2.5. IN THE EVENT OF AN ACCIDENT	14
2.6. EMI WARNING	14
2.7. MOTOR VEHICLE TRANSPORT.....	16
2.8. INCLEMENT WEATHER PRECAUTIONS.....	17
2.9. PRESCRIPTION DRUGS/PHYSICAL LIMITATIONS.....	17
2.10. ALCOHOL	17
2.11. BRAKING INFORMATION.....	17
2.12. OPERATION AROUND CURBS	17
2.13. OUTDOOR DRIVING SURFACES.....	18
2.14. PUBLIC STREETS AND ROADWAYS.....	18
2.15. MODIFICATIONS.....	18
2.16. ADDITIONAL SAFETY NOTICES AND WARNINGS	18
3. GENERAL OPERATING INSTRUCTIONS.....	19
3.1. LIFTING AND TRANSPORTING.....	19
3.2. GETTING READY TO RIDE.....	20
3.3. STARTING AND OPERATING.....	25
3.4. PREVENTING UNINTENDED MOVEMENT	29
3.5. REACHING AND BENDING.....	29
4. MAINTENANCE	34
4.1. NECESSARY MAINTENANCE EQUIPMENT AND TOOLS	34
4.2. WINTER INACTIVITY GUIDELINES.....	34
4.3. TIRE INFLATION AND REPLACEMENT.....	34
4.4. HARDWARE ADJUSTMENTS.....	36
4.5. BATTERY PACK CHARGING AND REPLACEMENT.....	36
4.6. CLEANING	38
4.7. DECK WEAR.....	38
4.8. BUMPER PAD REPLACEMENT.....	38
4.9. MOTOR MAINTENANCE	39
4.10. TURNING SPRINGS	39
4.11. PIVOT ROD BUSHINGS	39
4.12. TROUBLESHOOTING.....	39
5. WARRANTY AND CUSTOMER INFORMATION	41

6. APPENDIX.....	48
6.1. GOLFBOARD OWNER ON-BOARDING PROCEDURES	48

1. INTRODUCTION

1.1. WELCOME

Playing golf on a GolfBoard is fun, easy, and with just some simple instructions most anyone can quickly learn how to properly operate a GolfBoard. To ensure all new users have a safe and enjoyable experience, we have developed this comprehensive Owner’s Manual, which includes detailed operating instructions and safety information.

A comprehensive understanding of your GolfBoard and all its features will give you greater control and enjoyment when you ride. Please take the time to read this Owner’s Manual and familiarize yourself with all of the information that we have prepared for you before riding your new board. This manual contains important operating instructions and maintenance information that will help ensure safe and proper use.

1.2. USING THIS MANUAL

All users must follow the instructions and warnings contained in this manual for their safety. Do not attempt to operate the GolfBoard until you have attained adequate knowledge of its control and operating features. Damage caused by failing to follow instructions is not covered by the GolfBoard warranty and could result in personal injury to you or others, as well as damage to your GolfBoard.

This manual contains operating procedures to help you make informed decisions about safety. All GolfBoard owners that have either purchased or leased a GolfBoard assume the full responsibility and all liability for use of their GolfBoard, including by any additional user, and agree to instruct additional users they must watch the GolfBoard safety video located at: <https://goo.gl/O8skmJ>, or read the GolfBoard New User on-boarding procedures (included in the back this owner’s manual), or both; in order to become familiar with how to properly and safely operate the GolfBoard prior to use.

1.3. STAYING UPDATED

Always check the official GolfBoard.com website to make sure you have the most recent manual for your product. The latest version of the GolfBoard manual can be found at the bottom of each page at www.golfboard.com and is available for immediate download. If you find that the manual you are using is not the latest version, you must update your manual and all other related reference material you have generated or provided for your personal use or use of your business members or agents. If you have trouble finding the latest manuals, or have any questions regarding keeping your reference materials updated, contact GolfBoard immediately.

1.4. ADDITIONAL RESOURCES

Additional product service, support, and safety information is made available at the GolfBoard University website at golfboard.com/golfboard-university where you can learn more about safe operation, repair and use of your GolfBoard. The page is password-protected. Contact us for access.

1.5. NOTICES, CAUTIONS, WARNINGS, AND DANGERS

This Owner's Manual uses NOTICE, CAUTION, WARNING, and DANGER throughout. Please pay close attention to the following alerts emphasizing specific information.

NOTICE

Statements on practices not related to personal injury. May be used to indicate important operational characteristics or ways to optimize the use of your GolfBoard.

CAUTION

Indicates a potentially hazardous situation, which, if not avoided, may result in minor to moderate injury.

WARNING

Indicates a potentially hazardous situation, which, if not avoided, could result in serious injury or death. Always heed this information.

DANGER

Indicates an imminently hazardous situation, which, if not avoided, could result in serious injury or death. Always heed this information.

Print this manual and keep it with your GolfBoard as a reference for safe and enjoyable riding. Please pass this manual on to the next owner in case you transfer ownership. It is not possible or practical to warn you about all hazards associated with operating and maintaining the GolfBoard – you must use your own good judgment.

1.6. ABOUT THIS MANUAL

All specifications and descriptions are accurate at the time of publishing. SolBoards Inc. continually modifies material to be current and accurate and we reserve the right to make changes at any time, without notice and without obligation.

Copyright © 2020 SolBoards Inc.

All material in this manual, including, but not limited to, text, data, graphics, logos, and images, is owned and controlled by SolBoards Inc., and is protected by copyright, trademark, and other intellectual property rights. Material in the manual is made available solely for your personal, non-commercial use and may not be copied, reproduced, republished, modified, uploaded, posted, transmitted, or distributed in any way, including by e-mail or other electronic means, without the express prior written consent of SolBoards, Inc., for each instance. You may use material made available from the manual for your personal, non-commercial use only, provided that you keep intact any and all copyright and other proprietary notices that may appear on such materials.

1.7. GENERAL INFORMATION

1.7.1. Identification Numbers

The Serial Number or S/N is an 11-digit number located on the back right tray of the frame of the GolfBoard. Do not alter or remove this label as it is the identifier of your GolfBoard for purposes of registration, identification, and service.

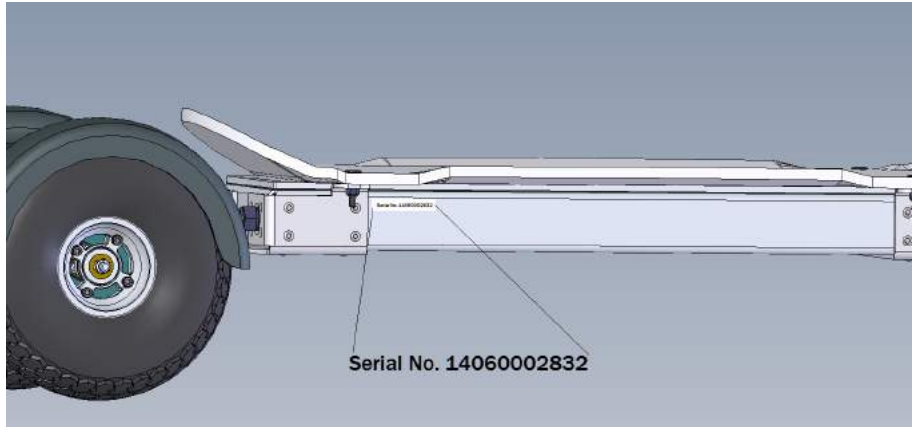
Identification Number	# of digits	Picture of Location
GolfBoard	11	

1.8. TECHNICAL SPECIFICATIONS AND KEY PRODUCT FEATURES

1.8.1. Technical Specifications

The GolfBoard is the only electric powered skateboard style personal transportation device developed from the ground-up for the unique needs of the golf industry, and is therefore far superior in performance, reliability, and ease of use compared to other personal golf transportation devices. The following technical specifications are provided for your review.

COMPONENT/DESIGN ATTRIBUTE	SPECIFICATION
BATTERY PACK	Li-Ion
NOMINAL VOLTAGE	44 Volts
FULLY CHARGED VOLTAGE	50.4 Volts
BATTERY CAPACITY	1.3 Kilowatt Hours
MAX PROPULSIVE POWER	3.2 Kilowatts
AC ADAPTER	110/220 Volt Smart Charger
CHARGE TIME (AFTER 18 HOLES)	Approximately 1 Hour
CHARGE TIME (COMPLETE CHARGE)	Approximately 2.2 Hours
AC ADAPTER INPUT VOLTAGE	110/220 Volts
AC ADAPTER INPUT FREQUENCY	50/60 Hertz
AC ADAPTER CURRENT (110/220V)	10/5 Amps
ECONOMY	Approximately \$0.10 Per 18 Holes

RANGE (ESTIMATED)	27 Holes/15 Miles
MOTOR TYPE	4 Pole Brushed DC W/ External Replaceable Brushes
GEARING	Hardened Machined Steel Gears
GEARCASE	No Maintenance Sealed And Lubricated
AXLE	Hardened Steel Alloy
MOTOR CONTROLLER	High Efficiency 250 Amp Industrial Motor Control
DRIVETRAIN	All-Wheel Drive With Locked Axles
GRADE	Maximum 25% Grade (14 Degree Slope)
BRAKING	4 Wheel Electronic Braking
SUSPENSION	Stainless Steel Flex Ends With Rubber Bump Stops
TIRES	11x4 or 13x5 Kenda K500 Turf Specific
SPEED CONTROL	Variable Speed Thumb Throttle Control
HIGH SPEED LIMIT	Approximately 10 MPH
LOW SPEED LIMIT	Approximately 5 MPH
HIGH SPEED LIMIT (SPORT BOARD)	Approximately 14 MPH
LOW SPEED LIMIT (SPORT BOARD)	Approximately 6 MPH
LENGTH	58" (147 CM)
WIDTH	20" (51 CM)
HEIGHT	12" (30 CM)
STABILITY BAR HEIGHT	42" (107 CM)
WEIGHT	145 Pounds (66 Kg) / 175 Pounds (79 Kg)
CARRYING CAPACITY	280 Lb. (127 Kg) / 350 Lb. (159 Kg)
GROUND FORCE PRESSURE (200 LB LOAD)	6.25 PSI
STEERING	Lean To Turn Steering/Coil Shock
OPERATING/STORAGE TEMPERATURE	-4°F To 110°F (-20°C To 43°C)
AMBIENT TEMPERATURE WHEN CHARGING	32°F To 110°F (0°C To 43°C)
FENDER MATERIAL	High Strength TPO Polyolefin
TRACTION DECK MATERIAL	Anti-Slip RhinoLiner® Deck
BUMPER SYSTEM	Replaceable Front And Rear Impact Bumper
COUNTRY OF MANUFACTURE	USA

1.8.2. Golfboard Key Product Features

1.8.2.1. Automatic Braking

The GolfBoard employs an automatic braking system which improves the safety of our device, and makes it easy to operate on even the hilliest terrain. It also reduces damage to the turf caused by conventional golf carts that can skid when the manual brakes are applied too hard. When the accelerator of our device is released, the board automatically comes to a stop in approximately 16 feet with a programmed proprietary braking curve that eliminates sudden deceleration in speed that can be caused by conventional braking systems. Once the board has come to a complete stop, a physical brake engages the rear wheel.

1.8.2.2. All Wheel Drive

The GolfBoard utilizes a locked/pinned axle on the front and rear gearbox assemblies. This locked axle means that the inside and outside tires are always rotating on the same axis which increases traction and reduces “tire spin” experienced with standard golf carts with limited slip differentials in grassy, muddy, wet, uneven, rocky, dirt, sand, and boggy terrain.

1.8.2.3. Gearbox

An 18:1 gear reduction system provides superior hill climbing ability. By combining high speed DC motors with this large gear reduction the resulting torque available at the wheel allows the GolfBoard to travel efficiently and with limited speed reduction up steep hills. This consistency of speed up and down steep hills, without the need of the driver to make adjustments as the terrain changes, makes GolfBoard extremely easy to operate.

1.8.2.4. Adjustable Spring Ends

The GolfBoard was designed with optimal performance and control in mind. The sometimes demanding environments found on golf courses required us to develop a comfortable and durable suspension system for the board, allowing the rider to feel a smooth ride across highly varying terrain.

1.8.2.5. Parking Brake

The GolfBoard has a physical, automatic anti-rollback restraint which stops the board from rolling away on hills.

1.8.2.6. Automotive Grade Li-Ion Battery

The GolfBoard battery is assembled in Poland using battery cells sourced directly from Samsung for consistent and reliable energy storage, providing users with consistent operation and performance for many years.

1.8.2.7. High power charger

The GolfBoard 10amp intelligent digital charger provides high speed charging in approximately 1-2 hours after each 18 hole round of golf.

1.9. INCLUDED COMPONENTS

The GolfBoard is available with the following components included in each product package:

1.9.1. **Standard components on all GolfBoards**

- Commercial Grade Golfboard, SportBoard, or GolfBoard PRO
- AC Adapter/Wall Charger
- Packaging

CAUTION

Sport Boards for advanced users only.

2. SAFETY INFORMATION

2.1. GENERAL SAFETY WARNINGS

- Before using, read operating instructions and thoroughly review safety information.
- Keep both feet on deck and hold stability bar tightly at all times while moving.
- 1 rider per board maximum.
- Drive slowly in turns and keep board straight up and down all slopes.
- Never operate under the influence of alcohol or drugs.
- Reduce speed and proceed with extra caution in crowded areas, when driving on wet, rough, or loose surfaces, and when traveling in reverse.
- Do not travel at speeds too fast for your experience, terrain, or visibility conditions.
- Allow at least 30 feet to stop when traveling at full speed.
- Do not follow too closely to other GolfBoards or golf carts.

2.2. GENERAL

MANDATORY!

Do not operate your new GolfBoard for the first time without completely reading and understanding this owner's manual.

Your GolfBoard is a state-of-the-art personal low speed transportation device designed to increase mobility.

Please be aware that the final selection and purchasing decision regarding the type of GolfBoard and optional features to be used is the responsibility of the user.

To the fullest extent permitted by applicable law, User releases Sol Boards, Inc., an Oregon corporation ("Sol Boards") (the maker of the GolfBoard), GB Leasing Capital, LLC, an Oregon limited liability company ("GB Leasing"), (owner or previous owner of the Board), and each of their present and future successors, assigns, directors, officers, members, managers, employees, agents, representatives and other personnel (collectively, the "Additional Released

Parties”), from and against any and all claims, actions, proceedings, damages, liabilities, and expenses of every kind, whether known or unknown and whether or not foreseeable, including, without limitation, those for or relating to bodily injury, property damage or loss of life, that in any way relates to, results from or arises out of the Board or its use by User, or any and all Additional Users.

As you begin using your GolfBoard, you will probably encounter situations in which you will need some practice. Simply take your time, and always first practice on an open, flat and grassy area. You will soon be in full and confident control as you maneuver up and down hills, and over moderate terrain.

There are certain situations, including some medical conditions, where the user will need to practice operating the GolfBoard in the presence of a trained attendant. A trained attendant can be defined as a family member or a professional specially trained in assisting a user in various activities.

If at any time a user feels that special situations or medical conditions makes instruction by a trained attendant necessary, then contact SolBoards, Inc. to be directed to a golf course or representative where such professional supervision may be available (Sol Boards makes no guarantees regarding the convenient availability of professional supervision, or any additional fees which may be applicable).

Below are some precautions, tips, and other safety considerations that will help you become accustomed to operating the GolfBoard safely.

2.3. SAFETY VIDEO

NOTICE



All riders are required to watch the safety video before first operating. A link to our Safety Video can be found at: <https://goo.gl/O8skmJ>



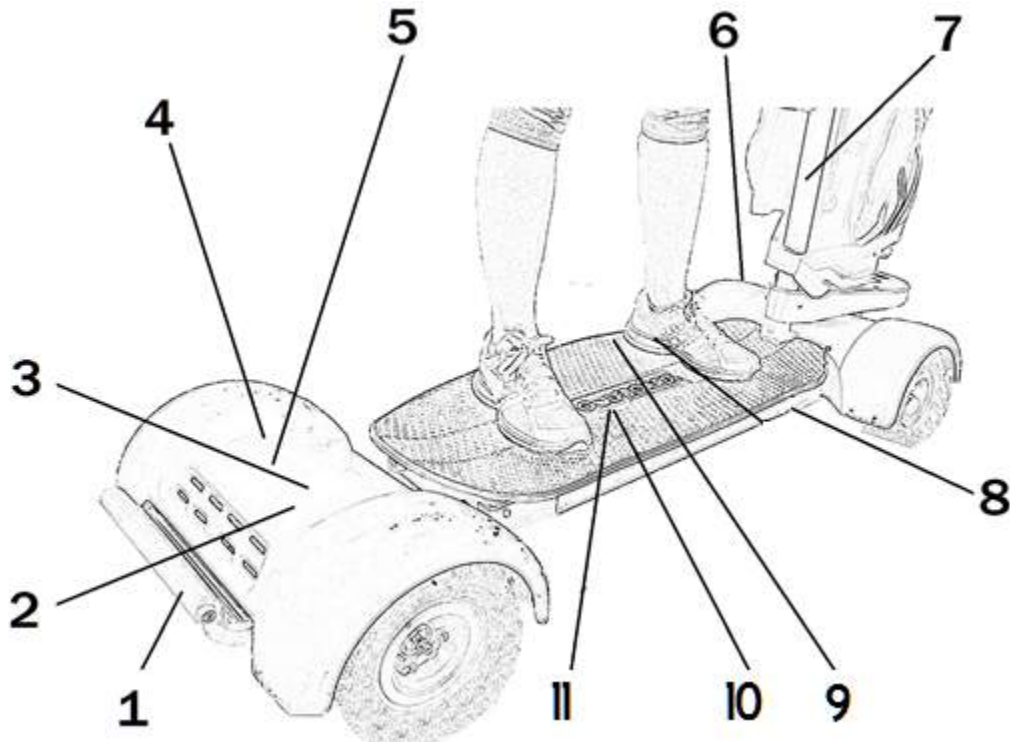





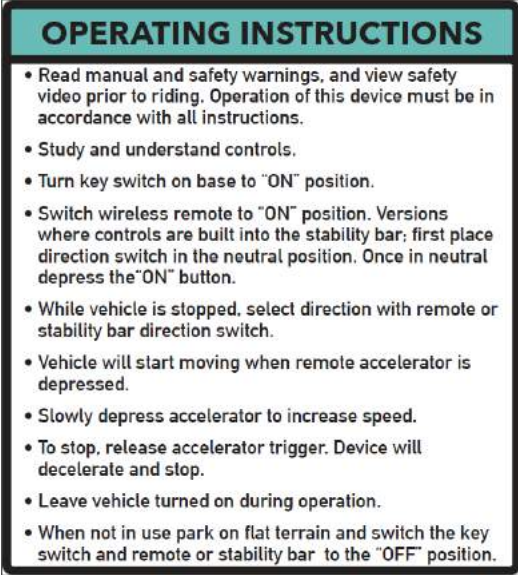

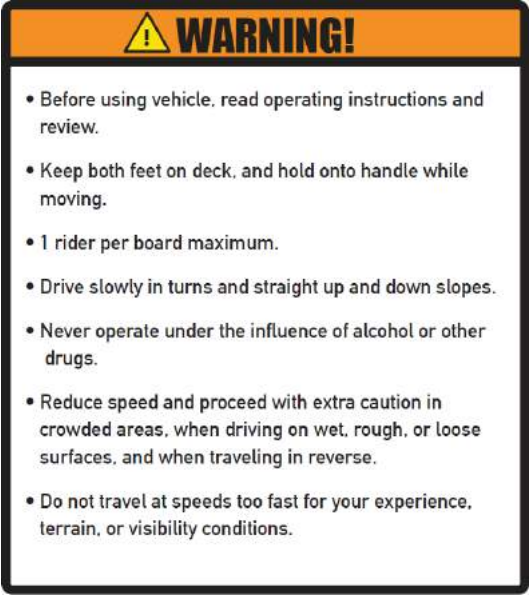



WARNING LABELS AND PICTOGRAMS







2.3.1. Description and Location of important labels



2.3.2. Description and Location of Important Labels Key

Number	Description	Label
1	Designated lift spot.	
2	Board number.	
3	Do not step area. Only step on the traction deck of the GolfBoard.	
4	Basic operating instructions.	

5	General warnings.	 <ul style="list-style-type: none"> • Before using vehicle, read operating instructions and review. • Keep both feet on deck, and hold onto handle while moving. • 1 rider per board maximum. • Drive slowly in turns and straight up and down slopes. • Never operate under the influence of alcohol or other drugs. • Reduce speed and proceed with extra caution in crowded areas, when driving on wet, rough, or loose surfaces, and when traveling in reverse. • Do not travel at speeds too fast for your experience, terrain, or visibility conditions. 								
6	Do not ascend or descend curbs on GolfBoard.									
7	General warnings.	 <table border="1" style="width: 100%; border-collapse: collapse;"> <tr> <td style="text-align: center;"></td> <td>RISK OF DEATH OR SERIOUS INJURY FROM FALLS AND COLLISION.</td> </tr> <tr> <td style="text-align: center;"></td> <td>WEAR FULL PROTECTIVE GEAR INCLUDING HELMET, WRIST GUARDS, ELBOW AND KNEE PADS TO REDUCE THE RISK OF SERIOUS INJURY.</td> </tr> <tr> <td style="text-align: center;"></td> <td>DO NOT RIDE AT NIGHT</td> </tr> <tr> <td style="text-align: center;"></td> <td>TO BE SAFE WATCH SAFETY VIDEO AND READ OWNERS MANUAL BEFORE RIDING.</td> </tr> </table> <p style="text-align: center; font-size: small;">To obtain user manual or safety training video, or if you have any other questions, call GolfBoard at 1 888-328-2841</p>		RISK OF DEATH OR SERIOUS INJURY FROM FALLS AND COLLISION.		WEAR FULL PROTECTIVE GEAR INCLUDING HELMET, WRIST GUARDS, ELBOW AND KNEE PADS TO REDUCE THE RISK OF SERIOUS INJURY.		DO NOT RIDE AT NIGHT		TO BE SAFE WATCH SAFETY VIDEO AND READ OWNERS MANUAL BEFORE RIDING.
	RISK OF DEATH OR SERIOUS INJURY FROM FALLS AND COLLISION.									
	WEAR FULL PROTECTIVE GEAR INCLUDING HELMET, WRIST GUARDS, ELBOW AND KNEE PADS TO REDUCE THE RISK OF SERIOUS INJURY.									
	DO NOT RIDE AT NIGHT									
	TO BE SAFE WATCH SAFETY VIDEO AND READ OWNERS MANUAL BEFORE RIDING.									
8	Unique board serial number for identification.	<h2 style="margin: 0;">Serial No. 14060002832</h2>								

9	Weight limit warning.	 <p data-bbox="732 262 1411 415">THE COMBINED WEIGHT OF RIDER AND GOLF BAG SHOULD NOT EXCEED 130 KG (287 POUNDS).</p>
10	Electrical hazard danger.	 <p data-bbox="732 541 1411 793">ELECTRICAL HAZARD. KEEP OUT. Death or serious injury may occur.</p>
11	General warnings.	 <p data-bbox="732 814 1411 970"> WARNING!  RISK OF DEATH OR SERIOUS INJURY FROM FALLS AND COLLISION.  DO NOT RIDE AT NIGHT.  WEAR FULL PROTECTIVE GEAR INCLUDING HELMET, WRIST GUARDS, ELBOW AND KNEE PADS TO REDUCE THE RISK OF SERIOUS INJURY.  TO BE SAFE WATCH SAFETY VIDEO AND READ OWNERS MANUAL BEFORE RIDING. <small>To obtain user manual or safety training video, or if you have any other questions, call GolfBoard at 1 888-328-2941</small> </p>

2.5. IN THE EVENT OF AN ACCIDENT



If the GolfBoard is involved in any kind of an accident in which it appears parts have been damaged, it is necessary have the vehicle checked by a qualified technician before further use.

WARNING

Laboratory tests have shown that electromagnetic and radio frequency waves can have an adverse effect on the performance of electrically powered mobility vehicles.

EMI WARNING

Electromagnetic and Radio Frequency Interference can come from sources such as cellular phones, mobile two-way radios (such as walkie-talkies), radio stations, TV stations, amateur radio (HAM) transmitters, wireless computer links, microwave signals, paging transmitters and medium-range mobile transceivers used by emergency vehicles. In some cases, these waves can cause unintended movement or damage to the control system. Every electrically-powered mobility vehicle has an immunity (or resistance) to EMI. The higher the immunity level, the greater the protection against EMI.

WARNING

The addition of accessories or components to the electrically-powered mobility vehicle can increase the susceptibility of the vehicle to EMI. Do not modify your GolfBoard in any way not authorized by the manufacturer.

There are a number of sources of relatively intense electromagnetic fields in everyday environment. Some of these sources are obvious and easy to avoid. Others are not apparent and exposure is unavoidable. However, we believe that by following the warning listed below, your risk of EMI will be minimized.

The sources of radiated EMI can be broadly classified into three types:

1. Hand-held portable transceivers (transmitters-receivers) with the antenna mounted directly on the transmitting unit. Examples include: citizen band (CB) radios, "walkie talkies", security, fire and police transceivers, cellular telephones and other personal communication devices. ** NOTE: some cellular telephones and similar devices transmit signals while they are ON, even when not being used.
2. Medium-range mobile transceivers Such as those used in police cars, fire trucks, ambulances and taxis. These usually have the antenna mounted on the outside of the vehicle.
3. Long-range transmitters and transceivers such as commercial broadcast transmitters (Radio and TV broadcast antenna towers) and amateur (HAM) radios. NOTE: Other types of hand held devices, such as cordless phones, laptop computers, AM/FM radios, TV sets, CD players, cassette players and small appliances such as electric shavers and hair dryers, as far as we know, are not likely to cause EMI problems to your powered vehicle.

2.5.1. Powered Vehicle Electromagnetic Interference (EMI)

Because EM energy rapidly becomes more intense as one moves closer to the transmitting antenna, the EM field from hand-held radio wave sources (transceivers) are of special concern. It is possible to unintentionally bring high levels of EM energy close to the powered vehicle's control system while using these devices. This can affect powered vehicle movement and braking. Therefore, the warnings listed below are recommended to prevent possible interference with the control system of the powered vehicle.

2.5.2. WARNINGS

Electromagnetic interference (EMI) from sources such as radio and TV stations, amateur radio (HAM) transmitters, two-way radios and cellular phones can affect powered vehicles.



WARNING

Following the warnings listed below should reduce the chance of unintended brake release or powered vehicle movement which could result in serious injury:

- 1) Do not operate hand-held transceivers (transmitters-receivers) such as citizen band (CB) radios, or turn ON personal communication devices such as cellular phones, while the powered vehicle is ON;*
- 2) Be aware of nearby transmitters, such as radio or TV stations and try to avoid coming close to them.*
- 3) On appearance of unintended movements or brake release occurrences, switch the powered vehicle OFF as soon as it is safe.*
- 4) Be aware that adding accessories or components, or modifying the powered vehicle, may make it more susceptible to EMI (Note: there is no easy way to evaluate their effect on the overall immunity level of the powered vehicle).*
- 5) Please report to us all incidents of unintended movement or brake release and note whether there is a source of EMI nearby. Report by calling 1-888-328-2841.*

2.7. MOTOR VEHICLE TRANSPORT

The GolfBoard should be stowed in the trunk of a car or in the back of a truck or van and properly secured. In addition, all removable GolfBoard parts should be removed and/or properly secured during motor vehicle transport.

WARNING

Always be sure your GolfBoard is properly secured when it is being transported.

2.8. INCLEMENT WEATHER PRECAUTIONS

Exposure of your GolfBoard to inclement weather conditions should be avoided whenever possible. If suddenly caught up in rain, snow, severe cold or heat while operating your GolfBoard, proceed to shelter at the earliest opportunity. Thoroughly dry your GolfBoard before storing, charging, or operating.

WARNING

Operating in rain, snow, salt, mist/spray conditions, and on icy slippery surfaces can have an adverse effect on the electrical system. Maintain and store your GolfBoard in a dry and clean environment at all times.

PRESCRIPTION DRUGS/PHYSICAL LIMITATIONS

The GolfBoard user must exercise care and common sense when operating his/her GolfBoard. This includes awareness of safety issues when taking prescribed or over-the-counter drugs or when the user has specific physical limitations.

Consult your physician if you are taking prescribed or over-the-counter medication or if you have certain physical limitations. Some medications and limitations may impair your ability to operate your GolfBoard in a safe manner.

WARNING

Do not operate your GolfBoard while under the influence of any Prescription or Over-the – Counter Drugs that caution against the operation of machinery or motor vehicles, as this may impair your ability to operate the GolfBoard safely.

ALCOHOL

The GolfBoard user must exercise care and common sense when operating his/her GolfBoard. This includes awareness of safety issues while under the influence of alcohol, or while smoking.

WARNING

Do not operate your GolfBoard while under the influence of Alcohol, as this may impair your ability to operate the GolfBoard safely.

BRAKING INFORMATION

Your GolfBoard is equipped with a powerful regenerative brake system which uses electricity to rapidly slow the vehicle when the throttle control lever returns to the center/stop position.

2.9. OPERATION AROUND CURBS

The GolfBoard should never be used to ascend or descend curbs. When absolutely unavoidable, use the following recommended procedure for ascending or descending curbs:

1. Approach curb at a 90 degree angle
2. Get off board prior to ascending or descending.
3. Place the board in “LOW” speed mode.
4. Walk along with board and slowly depress the throttle allowing the front wheels to ascend or descend the curb.
5. Continue until the rear wheels do the same.
6. Once the board is safely clear of any curbs you may continue standard operation.

Follow the video instructions beginning at 3:17 in the following instructional video for more information on recommended operation procedures around curbs: <https://goo.gl/O8skmJ>

NOTICE

Damage caused to the board by improper ascending or descending of curbs may be the financial responsibility of the user.

OUTDOOR DRIVING SURFACES

Your GolfBoard is designed to provide optimum stability under normal conditions—dry, level surfaces composed of concrete, blacktop, asphalt or grass. However, we recognize that there will be times when you will encounter other surface types. For this reason, your GolfBoard is designed to perform admirably on packed soil and gravel.

WARNING

Always reduce your GolfBoard's speed when driving on uneven terrain and/or soft surfaces. Avoid tall grass that can become tangled in the running gear. Avoid loosely packed gravel and sand. Avoid driving over or off curbs, rocks and other obstructions. If you feel unsure about a driving surface, avoid that surface.

PUBLIC STREETS AND ROADWAYS

You should not operate your GolfBoard on public streets and roadways. Obey all local pedestrian traffic rules. Wait until your path is clear of traffic, and then proceed with extreme caution.

2.10. MODIFICATIONS



We have designed and engineered your GolfBoard to provide maximum mobility and utility. However, under no circumstances should you modify, add, remove, or disable any feature, part, or function of your GolfBoard.

Do not modify your GolfBoard in any way not authorized by the manufacturer. Do not use accessories if they have not been tested or approved by the manufacturer.

2.11. ADDITIONAL SAFETY NOTICES AND WARNINGS



WARNING

If for any reason the GolfBoard does not stop when you release the Operating Lever, or stopped after longer distance than regular, immediately discontinue using the board. Switch to "OFF". Contact GolfBoard immediately.

NOTICE

Never use the GolfBoard for climbing up or riding down stairs. Never attempt to travel over obstacles which could cause damage to the board or rider.

Do not use the GolfBoard in heavy rain or extreme humidity conditions nor at temperatures below -30°C (-22°F) or above +45°C (+113°F).

Get acquainted with the GolfBoard and its operational features before using it. Operate the board slowly until you get used to its various functions, safety features, and to its braking capabilities and limitations. Watch carefully for pedestrians and drive your GolfBoard accordingly. In crowded areas always drive with the speed control lever at half speed. Drive only where permitted according to all applicable local laws and ordinances. Pay special attention not to hit persons or any objects around the vehicle.

GENERAL OPERATING INSTRUCTIONS

- Read manual and safety warnings prior to riding.
- Study and understand controls.
- Turn key to “ON” position.
- Turn on power button on the thumb throttle mechanism.
- While vehicle is stopped, select forward or reverse direction.
- Vehicle will start moving when thumb throttle is depressed.
- Slowly engage thumb throttle lever to increase speed.
- To stop, release thumb throttle lever and device will decelerate and stop.
- Leave vehicle turned on during normal operation.
- Park on flat terrain and switch to “OFF” when not in use.



CAUTION

Failure to understand how to operate your GolfBoard or not following the instructions above during operation may result in minor to moderate injury.

2.1. LIFTING AND TRANSPORTING

The GolfBoard is equipped with a front and rear bumper. To avoid injury, the board is best lifted by two people grasping both bumpers simultaneously. Do not attempt to lift a GolfBoard alone. Do not lift the GolfBoard by its fenders, as they will crack or break.



CAUTION

Failure to use proper lifting technique may result in minor to moderate injury.

The GolfBoard has been designed to be easily placed in the trunk of a car or back of a truck or SUV. While transporting a GolfBoard, the board should be secured with high strength tie-down straps, with one end secured to the board’s bumpers and the other end affixed to the vehicle. Always check to make sure the board is fully secured before operating any moving vehicle.



CAUTION

Failure to properly secure your GolfBoard during transport may result in damage to the GolfBoard, damage to the vehicle and/or minor to moderate injury to vehicle occupants.

2.2. GETTING READY TO RIDE

This section discusses what steps are required prior to riding the GolfBoard. This section also includes important information about weight limits and loading of your GolfBoard.

Before first riding the GolfBoard we urge you to:

- Read this owner's manual.
- Make sure you understand safety messages.
- Understand and know how to operate all controls.
- View and comprehend [GolfBoard Safety Video](#).
- Understand new user on-boarding procedures as explained in the supplemental section at the end of this operating manual.

Before each subsequent ride, ensure that:

- You don't have alcohol or drugs in your system.
- You are in good physical and mental condition.

2.2.1. Riding Gear

We recommend the following clothing items be worn when riding the GolfBoard for safety and comfort. Do not wear clothing that is too loose as there is a risk of getting it tangled on wheels, steering, etc.

- Closed toe shoes with non-slip soles are recommended.
- Clothing that is secure and fitting in a way that can't catch on any components of the GolfBoard (such as the stability bar) during use including when stepping on and off.

2.2.2. Stability Bar Installation

1. First remove the attachment bolt on the mounting block near the traction deck of the GolfBoard. Unscrew counter clockwise with a 6mm metric Allen key. Once fully unscrewed, pull the screw completely out.
2. Place the stability bar into the mounting block. The mounting stability bar should be mounted with the bag mounting accessories facing outwards.

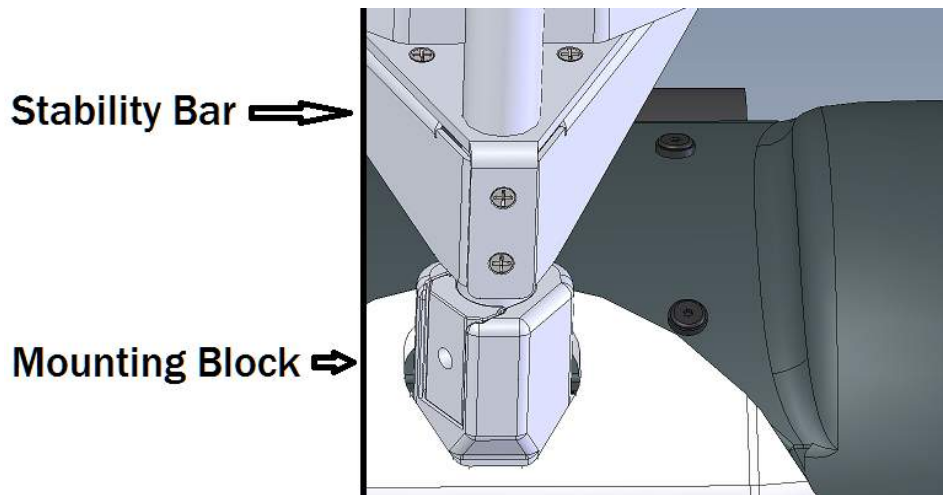

3. Replace the attachment screw on the mounting block and finger tighten. Once finger tight, use the Allen key to tighten the bolt down securely to 30 Nm (22 foot-pound). Ensure that the locking washer and flat washer are installed in the same orientation as when removed.



CAUTION

Check to ensure that all components of the stability bar are securely mounted and no damage occurred during transport before operating your GolfBoard.

2.2.4. Attaching Your Golf Bag

The following steps provide instruction on the proper attachment of a standard golf bag to the stability bar of your GolfBoard.

Step #	Step Description
1	Remove the strap on the top bag support by pulling out on the buckle release arm.
2	Expand the lower strap all the way outwards until it reaches its maximum strap loop size.
3	Place your bag onto the stability bar bag support base.
4	Wrap the 2" strap on the top bag support around your bag and through the carry handle.
5	Feed the strap through the buckle.
6	Pull the strap tight and secure the buckle by firmly pressing inwards on the buckle release arm.
7	Pull up and seat the lower strap around the flat circular base of your golf bag.

8	Perform the same tightening operation as explained for the top strap, making sure that your bag is secured from both front and back, and side to side movement.
---	---

 **CAUTION**

The bottom strap should be kept tight and away from the tires and moving components of the GolfBoard at all times of operation and your bag should be installed while the GolfBoard is on an even surface.

NOTICE

Do not ride in heavily populated areas or around vehicle traffic while learning.

Stay on smooth and flat terrain while practicing.

Pay attention to your surroundings.

Do not operate cell phones or other electronic devices while riding.

Even if you have experience with other board sports, take time to learn how the GolfBoard performs and handles. The GolfBoards' size, weight and power are very dissimilar from other board sports.

 **WARNING**

Your golf bag must be securely fastened to your GolfBoard at all times. Serious injury or death can occur if your bag is loose.

2.2.5. Rider Training

All new GolfBoard riders should take the time to become familiar with how the GolfBoard works and handles. This starts with viewing the safety video and reviewing the supplemental new user on-boarding procedures.

NOTICE

See Supplement 5.1 on page 46 “On-Boarding Procedures” to get acquainted with the correct operation of this product.

2.2.6. Pre-Ride Inspection



WARNING

If you notice any damage or problems in the pre-ride inspection, please correct them if they are in the scope of the general maintenance of the board or contact your GolfBoard authorized repair specialist.

Check the following items before stepping onto the GolfBoard:

- **Accelerator:** Before turning on your GolfBoard, ensure the thumb throttle lever is functioning without obstruction and moves slowly without binding.
- **Wheels and tires:** Use an air pressure gauge to check that the tires are properly inflated. See “Tire Pressure”. Look for signs of excessive wear or damage to the tires.
- **Loose parts:** Walk around the GolfBoard and look for anything that appears unusual, such as loose parts, missing hardware, or items obstructing the wheels.
- **Fenders:** Check that the fenders are securely mounted to the GolfBoard assembly.

2.2.7. Loading Guidelines



DANGER

Overloading the GolfBoard can cause a crash and you can be seriously hurt or killed. Follow load limits in this manual.



WARNING

The combined weight of rider and golf bag should not exceed 287 pounds (130 kg).



NOTICE

Your GolfBoard is rated for a maximum weight capacity of 287 pounds. MANDATORY! Stay within the specified weight capacity for your GolfBoard. Exceeding the weight capacity voids your warranty. We will not be held responsible for injuries and / or property damage resulting from failure to observe weight limitations. Do not carry passengers on your GolfBoard. Carrying passengers on your GolfBoard may create unstable conditions.

2.3. STARTING AND OPERATING

2.3.1. Instructional Video

For detailed instruction on the proper operation of the GolfBoard please refer to the following video on our YouTube Channel:

LINK: <https://goo.gl/O8skmJ>



2.3.2. Location of Controls



1) On/Off Switch

The power switch is part of the thumb throttle mechanism and is used for turning the GolfBoard ON for operation and OFF for charging and storage.



2) Charging Port

Operation of the charging system of the GolfBoard is outlined in section “charging.”

1) On/Off Key Switch

The key switch on the GolfBoard is shown in the image below. The key should be located in the vertical position when “OFF” and horizontal when “ON”. The key should be removed whenever the board is parked or in use. The key can be removed when in either position.



2) Stability Bar Controls

The location of the Thumb Throttle Stability Bar controls and key design features are outlined below:

1 - On/Off switch
2 - High/Low Switch
3 – Accelerator
4 - Fwd/Rev Switch
5 - GolfBoard battery meter



2.3.5. Turning on the GolfBoard:

Use the following steps each time you turn on your Thumb Throttle GolfBoard. The image on page 29 is also provided as an additional reference.

Step #	Step Description
1	Ensure board is in a wide open area, clear from vehicles, curbs, parking blocks, and other obstacles
2	Switch the speed switch on the stability bar into “LOW”

3	Switch the direction switch on the stability bar into neutral “N”
4	Turn on the GolfBoard with the key switch
5	Turn on the thumb throttle with the throttle power switch
6	Flip the direction switch on the stability bar into forward “F”
7	Once the LED on the thumb throttle is illuminated and your direction forward “F” is selected, the board is armed and ready for operation.

NOTICE

You must always turn the board on with the Direction stability bar toggle switch in neutral. Failure to complete Step #3 above will result in the board being non-operational until the procedure is followed.

2.3.6. Estimating Range

On both models of GolfBoard, there are LED battery status indicators designed to provide users with range estimates and warnings for when recharging must occur. The GolfBoards should be recharged fully after each use.



DANGER

When the red LED light is exclusively illuminated on the thumb throttle the GolfBoard has 25% or less battery capacity remaining and therefore, the board may come to a stop at any time without notice. As such, user should operate the GolfBoard in low speed whenever the Red LED light is exclusively illuminated.

NOTICE

An automatic reduction in speed may occur when approximately 25% of the battery pack capacity is remaining. This programming feature is designed to increase the range of the board by reducing the available top speed to conserve battery capacity.

NOTICE

When driving the GolfBoard, the LED gauge will read inaccurately due to voltage sag of the battery pack. Users should only reference the LED meters when the board is at a stand-still.

2.3.6.1. Thumb Throttle Board LED Gauge Description

The Thumb Throttle Board provides users with a 3 color display of remaining battery capacity. When fully charged all three LED lights (Green, Yellow, Red) will be illuminated. As the board begins to be operated and battery energy consumed through operation, the green LED light will start to fade away leaving just the yellow and red LED light illuminated. Once the yellow light has faded away in a similar manner, leaving just the red LED illuminated the board has approximately 25 % battery capacity remaining and should be recharged immediately.

The following tables provide additional instruction on how to interpret the LED battery status indicators on the remote and stability bar for each respective GolfBoard model:

2.3.6.2. Thumb Throttle Board LED Gauge Key

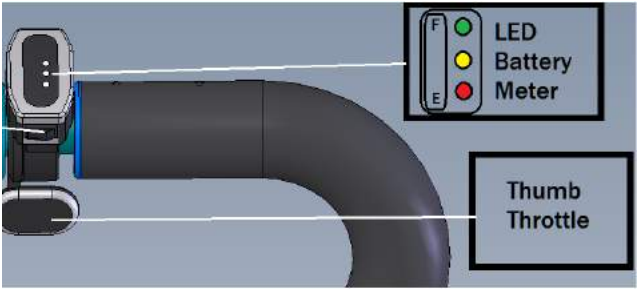
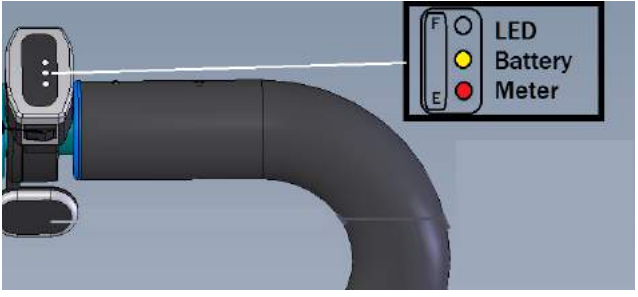
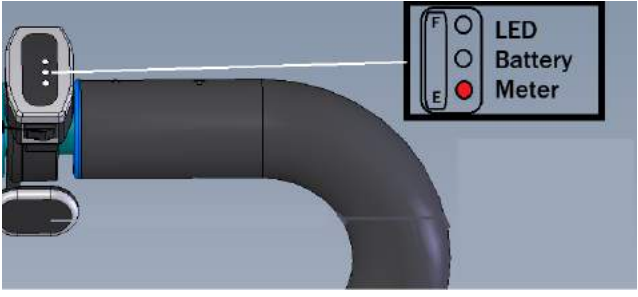
Battery Capacity Remaining	LED Gauge Picture	LED Illuminated
100%		ALL
75%		Yellow and Red
25%		Red Only

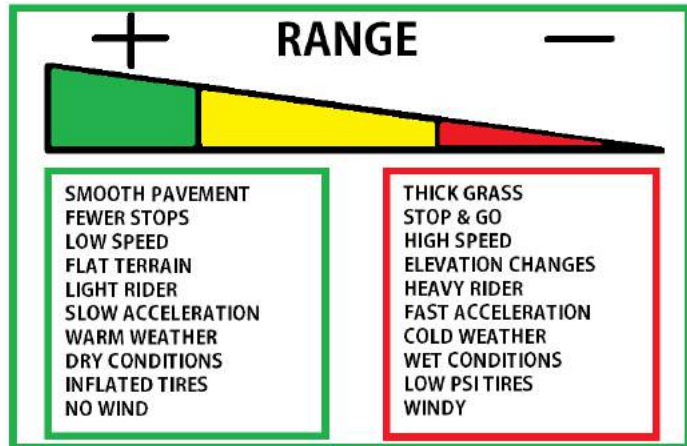

2.3.7. Maximizing Range

The range of the GolfBoard is defined as the distance the vehicle will travel on a single full charge of the onboard battery pack. The range of the GolfBoard is an estimate based on varying factors.

Some of the factors that affect range include changes in elevation, speed, acceleration, number of starts and stops, ambient air temperatures. Tire pressure and payload are also important considerations.

We suggest that you ride conservatively when you first get your GolfBoard to get to know your GolfBoard and your travel routes. Once you become familiar with the range requirements of your travel routes, and performance of the GolfBoard, you can then adjust your riding characteristics if you so desire.

WARNING

SolBoards Inc. designed the GolfBoard to travel a minimum of 18 holes on a single charge. Riders should follow the details on battery state-of-charge section during every riding occasion.

NOTICE

The graphic describes general factors effecting GolfBoard range. These graphics are meant to help owners understand the factors that can increase or decrease the range of the GolfBoard.

PREVENTING UNINTENDED MOVEMENT

If you anticipate being in a stationary position for an extended period of time, turn off the power. This will prevent unexpected motion from inadvertent throttle control lever contact. Do not turn off power when on a steep hill as the board can roll away. Always park on a flat surface when the board is turned off.

2.4. REACHING AND BENDING

Avoid reaching or bending while driving your GolfBoard. Bending forward creates the risk of accidental loss of balance. Bending to the side while moving creates the risk of tipping or falling.

It is important to maintain a stable center of gravity. The GolfBoard user must determine his/her personal limitations prior to use.

WARNING

Do not bend, lean, or reach for objects if you have to pick them up from the GolfBoard deck or from either side of the GolfBoard . Movements such as these may change your center of gravity and the weight distribution of the GolfBoard and could cause you to fall.

WARNING

Keep your hands away from the tires and wheels when driving. Be aware that loose fitting clothing can become caught in drive tires and wheels.

4. MAINTENANCE

NOTICE

Routine maintenance requirements of the GolfBoard as well as a general maintenance schedule are listed below. By following the steps outlined, owners will have the information needed to correctly maintain and prolong the life of their GolfBoard(s). In the case that owner is unable to perform any of the following care and maintenance procedures, SolBoards Inc., the manufacturer of the GolfBoard, can assist in finding a regional service provider. Failure to follow maintenance requirements will void the manufacturer's warranty.

WARNING

Failure to follow maintenance instructions and guidelines will void warranty. Do not open battery box, motor control assembly, or motor. Doing so will void your warranty and could result in injury or death.

NECESSARY MAINTENANCE EQUIPMENT AND TOOLS

The following equipment and tools are required to perform general maintenance tasks on the GolfBoard:

Tire pressure gauge - Designed for use with standard Schrader valves.

Allen key set – For general maintenance, and access to diagnostic port.

Socket set – Standard socket set for tire replacement and other general maintenance.

Torque wrench – For accurate installation of axle nuts and deck mounting nuts.

Cleaning tools – Plastic bristle brush, rags, and approved cleaning solutions.

Grease gun – Lubrication of gear boxes based on drive-time hours. Uses a standard grease gun and zerk fitting.

4.1. WINTER INACTIVITY GUIDELINES

In the case of seasonal inactivity or shutdown period the following procedure should be followed:

1. Completely charge the batteries.
2. Remove AC Adapters from power outlet and charging port on each GolfBoard.
3. Store GolfBoards in a cool dry place, away from the elements, however, do not store in a location that is constantly below 32 degrees Fahrenheit.
4. Batteries will discharge while in storage so you must fully charge batteries every 30 days.

4.3. TIRE INFLATION AND REPLACEMENT

WARNING

To prevent serious injury or death from tire explosion never inflate above 40 psi and use a manual pump to prevent over-inflation.

The GolfBoard employs a turf style tire with a 4-ply construction and inner tube. The tires are designed for durability and exceptional wear resistance in turf environments. Tires need to be checked before each operation for proper inflation and condition. Because the GolfBoard uses a 4wd system, the tires will wear more evenly than standard 2 and 1 wheel drive vehicles. For this reason, GolfBoard tires need to be replaced as a set (all 4 at once) to ensure that the board will have equal traction and rotation characteristics.



GolfBoard tires that are over-inflated will reduce the amount of traction you have on the ground while tires that are under inflated can lead to dangerous operational conditions. Proper inflation pressures will prolong the life of your tires and help ensure the smooth operation of your GolfBoard. For these reasons the tire pressure needs to be watched carefully, and checked before each use. Inflate to 30 psi/Standard, 40 psi/PRO.



WARNING

It is critically important that the psi air pressure indicated on each tire be maintained in pneumatic tires at all times. Do not underinflate or overinflate your tires. Low pressure may result in loss of control, and overinflated tires may burst. Failure to maintain the air pressure rating indicated on pneumatic tires at all times may result in tire and/or wheel failure. Inflate your tires from a regulated air source with an available pressure gauge. Inflating your tires from an unregulated air source could overinflate them, resulting in a burst tire.

Replacement

When tire wear becomes evident or a flat tire is discovered, you must replace the tires or injury to operators and/or damage to the GolfBoard could occur. The GolfBoard rim uses “split rim” technology, which makes tire replacement procedures possible with basic hand tools.

WARNING

To prevent serious injury ensure that all air pressure has been removed from the inner tube prior to disconnecting the outer half of the rim from the inner half of the rim.

Follow this procedure for removing and replacing worn tires:

1. Remove air from inner tube.
2. Remove 4 Allen bolts securing outer half of rim.
3. Slide the outer half of the rim off.
4. Slide off used tire and tube.
5. Replace tire and Inner tube with new genuine GolfBoard parts.
6. Follow removal procedure in reverse, making sure not to pinch the inner tube between the tire halves when sliding together.
7. Carefully re-inflate the tire to proper psi.

For more information on tire or tube replacement procedures visit the following GolfBoard University webpage: <http://www.golfboard.com/golfboard-university>. If you haven't had prior access, contact us for password information.

4.4. HARDWARE ADJUSTMENTS

Vibrations from normal use can cause some bolt and screw fittings to loosen over time. Check all fasteners for tightness before each use, especially if used on rough surfaces that cause vibration.

4.5. BATTERY PACK CHARGING AND REPLACEMENT

4.5.1. Battery Pack Charging Overview

NOTICE

- Always unplug the GolfBoard charger once the charge has been completed.
- Extreme temperatures will affect battery life, especially during charging. Avoid charging in direct sunlight or in very hot or cold temperatures. This will reduce the life of the battery considerably. We recommend charging the battery at room temperature (approximately 20 °C / 68 °F).
- A lithium Ion battery does not have a memory effect, which means that the battery's maximum energy capacity is not affected if it is repeatedly recharged after only being partially discharged. The battery does not need to be completely discharged before recharging. We recommend charging the battery after every use.
- When the battery is depleted to the level where there is risk it could fall into deep discharge, the battery will automatically shut down power until the being recharged.

The lithium battery is fully contained and requires zero maintenance during its operational life. Charging of the GolfBoard battery should be done ONLY with the original charger provided to you, or a factory direct replacement. The following notes and procedures will help ensure your battery last for many years to come.

WARNING

Do not use charger that has obvious signs of damage to the cable, housing, or the connector.

4.5.2. Charging Procedure



The GolfBoard battery should be charged after each use. The GolfBoard AC Adapter must be kept in a cool, dry, and dust/debris free environment during storage and usage. The AC Adapter has one wire that plugs into any standard 120 or 240 volt power outlet, with the other end plugging into the GolfBoard charge port. Be sure the AC Adapter is disconnected from AC power (at wall or at Adapter) before plugging the Adapter cord into the GolfBoard charge port. Once connected to the charge port, AC power can be connected to the Adapter. When the battery is below "full charge" state the AC adapter will automatically charge the pack when plugged in. When the charge is complete, the charging will automatically stop and go into "sleep" mode. AC adapter will not over-charge the GolfBoard battery.



4.5.2.1. Average Recharge Time

- After one 18 Hole Round: 1.15 Hours
- Fully depleted battery pack: 2.5 hours

4.5.2.2. LED Charger Status Lights

Charge Status (Charging)	Charge Status (Done Charging)
The Charger is charging the board and working properly when the LED turns RED/ORANGE and the Charger fan is running.	When the GolfBoard is finished charging, the LED will turn GREEN. The fan will not be running when the LED is GREEN, also indicating the charger is not running
	

Charger models may vary

4.5.2.3. Charger Plug Removal

When removing the charging plug from the charger socket, grip the metal part of the plug firmly and pull outwards. Never pull or yank directly on the cable or rubber strain relief.



4.5.3. Replacement

Replacement of the battery pack should be completed after approximately 1,600 18 hole rounds, or approximately 5 years when used every day of the year, or when there is a noticeable drop in performance or range.

For more information on battery replacement procedures visit the [GolfBoard University](#) webpage.

WARNING

Only certified service providers should perform any work surrounding the GolfBoard battery pack. Removal or replacement of the GolfBoard battery should never be performed by end users. Serious injury or death could occur if not avoided.

NOTICE

The battery pack used on the GolfBoard is maintenance free. Aside from normal charging, there is no other maintenance to perform on the battery modules. The batteries are fully enclosed within the GolfBoard body away from dirt, debris, and moisture.

SolBoards Inc. highly recommends cycling the batteries at least once every 2 months to maximize the life of the battery pack. Cycling is the discharge to ~30 % SOC (state of charge) or less, and then charging to 100% SOC.

Failure to plug the charger into the battery first, followed by plugging the charger AC cord into the wall outlet, may cause the board to not charge properly.

4.6. CLEANING

The GolfBoard should be cleaned with non-corrosive biodegradable cleaners. Pressure washers or open water (hosing down) of the GolfBoard voids the manufacturer's warranty. Instead cleaning should be done with a damp rag. The undercarriage should be cleaned using compressed air. The small surface area and smooth material of the GolfBoard allows this hand cleaning approach to be performed in most cases without significant time requirements.

The GolfBoard is water resistant and can be operated in all common Golf Course conditions, including dew and light rain conditions. The GolfBoard should not be operated in large puddles, water hazards, heavy rain, or similarly wet environments.



CAUTION

Failure to follow the cleaning precautions or failure to observe operation guidelines can result in water damage to the GolfBoard that is not covered under warranty.

4.7. DECK WEAR

The deck or standing surface of the GolfBoard is a consumable component, and will wear throughout the operational life. It is also possible that the traction material can be damaged from misuse. Metal spikes are prohibited from use on the GolfBoard decks. SolBoards, Inc. provides genuine replacement decks in the case of excessive wear or damage. Removal is completed by removing the 4 deck mounting bolts. Replacement with a new deck follows the reverse procedure.

4.8. BUMPER PAD REPLACEMENT

The GolfBoard uses standard bumper pads, which have high UV resistance, but they can be damaged from normal wear and tear as well as from prolonged exposure to the sun. Replacement should be conducted whenever the pad is visually damaged. Each pad uses a simple Velcro split mounting method and should be removed and replaced when needed.

4.9. MOTOR MAINTENANCE

The GolfBoard utilizes a high efficiency 4 pole brushed motor. The motors require zero maintenance besides occasional replacement of brushes. The following brush replacement guidelines present general instruction to determining if your motor(s) brushes are in need of replacement. Please contact GolfBoard Technical Support with any questions on service and repair at 1-888-328-2841. Genuine GolfBoard replacement parts must be used.



WARNING

Before servicing Motor Brushes, switch off the GolfBoard to avoid electrical shock.

Brush Replacement Guidelines	Approximate operating time before replacement is required
Replacement 1	1,800 hours
Replacement 2	3,200 hours
Brush material height starting	Brush material height when replacement is required
3/4"	1/4"

NOTICE

The first set of brushes will last in between 1,500 and 2,000 hours of drive operation. The second set of brushes last for approximately 80% of the original brush sets life. After the second set of brushes has been consumed and needs replacement, GolfBoard motors should be replaced by a factory certified service provider.

4.10. TURNING SPRINGS

The GolfBoard utilizes high strength steel springs on the front and rear truck assemblies which aid in turning and stability. It is generally recommended to replace these springs at least once per year to maintain ideal operational characteristics. After continued use these coil springs may lose some of their original spring force making it more challenging to ride in a straight line. Replacement turning springs are available for purchase. There are two turning springs on each truck assembly (4 springs per board). Whenever these springs are serviced, all 4 springs should be changed at the same time to ensure the board functions to original specifications.

4.11. PIVOT ROD BUSHINGS

The GolfBoard has brass bushings located between the pivot axle and truck assembly which may wear out over time through daily use, or get damaged if the truck assembly is impacted by curbs or other obstacles. When worn or damaged, the board may feel a bit unstable, at which time the pivot rod bushings should be replaced. In a high use environments, these bushings should be inspected (and / or changed) at least annually. Replacement pivot rod bushings are available for purchase. There are 4 bushings on each truck assembly (8 bushings per board). Whenever these bushings are serviced, all 8 bushings should be changed at the same time to ensure the board functions to original specifications.

4.12. TROUBLESHOOTING

The following table provides troubleshooting and repair instructions for symptoms encountered when operating the GolfBoard. It presents the best ways to handle the faults. The table contains three columns:

Symptom - describes the functional problem that results from the fault.

Probable Cause - lists all probable causes for the relevant symptom. The probable causes are listed logically by order of probability: the first one is the most probable.

Remedy - lists the action to be taken to solve the problem. The appropriate remedy appears opposite each probable cause. These remedies should solve the problem; if not, continue down the list to the next cause/remedy.

NOTICE

Remember that you may contact GolfBoard at any time for further professional support. Never perform repairs without proper training and certification.

No.	Symptom	Probable Cause	Remedy
1	GolfBoard does not start.	Board may be set to off position, or battery is not charged.	Make sure power switch is in the on position, and/or charge battery.
2	GolfBoard stops operating after operating for some time.	The motors may be overheating. The battery may be dead	Turnoff the board, and allow motors to cool.
3	Intermittent power while riding.	Battery capacity low. Overheating motors Faulty battery.	Charge batteries for at least 2 hrs. Let motors cool Have a qualified technician remove battery cover and check the battery. If your range has slowly decreased over time your battery capacity may be faulty. For replacement, contact GolfBoard.
4	Reduced speed while riding.	Battery may be almost fully discharged. The motors may be overheating. Low speed switch flipped.	Charge battery. Turnoff the board, and allow motors to cool. Check to see the remote was not accidentally flipped to low speed.
5	Unable to charge.	Improper connection to golfboard charge port. AC adapter not plugged properly to electrical outlet.	Check charger connection to charge port. Check AC adapter power cord.
6	Only front or rear motors are spinning.	Failed connections.	Check connection to motor controller.

7	Tire is rubbing on fenders.	Improper wheel replacement.	Order proper size replacement wheels. Install according to standard tire installation procedures.
8	Flat tire and unstable driving.	Low air pressure. Puncture.	Pump to normal air pressure. Repair the tire.
9	When releasing the accelerator on level surface, the GolfBoard does not stop in the normal distance or more than 20 feet.	Out of adjustment or faulty motor controller.	Contact GolfBoard for professional servicing.

5. WARRANTY AND CUSTOMER INFORMATION

GolfBoard 4-Wheel Drive Electric Personal Mobility Assist Device One Year Limited Warranty (United States). Included with every GolfBoard purchased. An optional 3-year Extended Warranty is also available and may be purchased separately. Ask your Sales Representative for details.

What does this Limited Warranty cover?

Sol Boards Inc. (“Sol Boards”), the maker of the GolfBoard 4-wheel drive electric personal mobility assist device (“GolfBoard”), warrants that, subject to the limitations and exclusions set forth below in this Limited Warranty: (1) a new GolfBoard that is both purchased from Sol Boards and situated in the United States will, at the time of initial purchase from Sol Boards, prior to any use of the GolfBoard (“Time of Purchase”), be free from defects in materials and workmanship; and (2) after the Time of Purchase, for the applicable Warranty Period(s) set forth below, that any Warrantied Part in the GolfBoard (as set forth below, collectively the “Warrantied Parts”) will be free from defects in materials and workmanship under normal service and use for the GolfBoard’s intended use on golf courses.

What is the Warranty Period?

This Limited Warranty commences on the date of the original purchase of the new GolfBoard from Sol Boards (“Purchase Date”) and remains in effect for the period of one (1) year from the Purchase Date for the Warrantied Parts, (the “Warranty Period”). The Warranty Period is not extended if any GolfBoard or Part is repaired or replaced. A repaired or replaced GolfBoard or Part is warranted only for the remaining balance of the original Warranty Period, if any.

What are the 1-Year Warrantied Parts?

Parts and Components that are covered for a period of 1 year by this Limited Warranty include those parts and components heavily engineered to resist damage or problems occurring or arising after the Time of Purchase if the Board is used properly. Parts and components that are covered by this Limited Warranty for 1 year from the purchase date (1-year Warrantied Parts) for any damage or problems occurring or arising after the Time of Purchase include, without limitation, the GolfBoards’:

- Component tray

- Spring plates
- Stability bar tube
- Trucks
- Gearbox and axles
- Motor controller
- Wiring
- Wheel/Hub Assembly
- Motor
- Battery

What does this Limited Warranty not cover?

This Limited Warranty does not cover any parts or components unless specified as a “warranted part”, for example any GolfBoard part or component that needs replacement due to normal wear and tear (Consumable parts and components). Consumable parts and components that are not covered by this Limited Warranty for any damage or problems occurring or arising after the Time of Purchase include, without limitation, the GolfBoards:

- Tires & tubes
- Deck
- Fenders
- Under carriage protection rollers and gear box cover
- Bumper bars, pads and covers
- Bushings and springs
- Motor Brushes
- Thumb Throttle
- Stability Bar Buttons

All of which are components that (depending on frequency of use, and/or abuse) may need periodic replacement due to normal wear and tear.

The GolfBoard is not an extreme terrain vehicle. It is not designed to go over curbs, do jumps and is not designed to be used in extreme conditions or extreme temperatures nor is it intended or warranted for such use. The GolfBoard must not be submerged or power washed, in that any water which gets into the component tray will damage the boards’ electronics and nullify this warranty.

This Limited Warranty does not cover any problems with the GolfBoard or any Part caused by or resulting from unreasonable or improper use or any other external cause, including, but not limited

to, accident, collision, abuse, misuse, neglect, improper maintenance, power washing, mishandling, improper shipping or other transportation, alteration, modification, weight restrictions being exceeded, failures to follow maintenance programs, procedures or schedules, or failure to adhere to safety instructions, theft, fire, or acts of God (i.e. lightning, hail, flooding, fire, etc.). Warranty is void if any of the above criteria is not strictly adhered to during ownership.

Examples of misuse or neglect that are not covered by this Limited Warranty include, without limitation, any problem with the GolfBoard or any Part caused by or resulting from riding over curbs, jumping, use of the GolfBoard outside of a golf course or outside of course boundaries, use of the GolfBoard in temperatures below 32 degrees Fahrenheit or above 110 degrees Fahrenheit, or failure to keep the GolfBoard battery properly charged, particularly during the off-season, per specific procedures provided by Sol Boards.

Storage of boards outside in inclement weather, running into trees, walls, ponds and lakes, are further examples of neglect and misuse.

This Limited Warranty does not cover damage, defects or deterioration in: (i) appearance, (ii) cosmetic or decorative items, (iii) any problems with the GolfBoard or any part caused by, relating to or resulting from the actions or omissions of any third-party who performs work on the GolfBoard or part or from installation of parts or accessories that are not original equipment.

This Limited Warranty does not cover the GolfBoard's charger, which, as a detached item, is prone to loss, theft and damage. Sol Boards offers replacement chargers. Contact Sol Boards for current pricing information.

This Limited Warranty does not cover GolfBoards purchased or situated outside of the United States.

This Limited Warranty does not cover any defect that arises or appears more than thirty (30) days prior to the date that Sol Boards is notified of the alleged defect.

Who is covered?

This Limited Warranty covers the original purchaser of a new GolfBoard and anyone else who owns the GolfBoard during the Warranty Period (all of whom may be referred to as a "Purchaser") during such period of time as they own the GolfBoard. A Purchaser may assign the Purchaser's warranty rights under this Limited Warranty to a commercial lessee of the GolfBoard to whom the Purchaser grants sole possession and control of the GolfBoard pursuant to a written lease agreement. A lessee (and a Purchaser) may have other GolfBoard maintenance and repair obligations that extend beyond those identified in this Limited Warranty, including, as applicable and without limitation, obligations described in any applicable course acknowledgement agreement. Rentals to consumers or users (i.e. golf course rentals to customers) are specifically excluded from the above assignment rights.

What will Sol Boards do to correct problems?

If a Purchaser believes a GolfBoard requires repair due to the malfunction of one or more of the GolfBoard's Parts, the Purchaser may, in accordance with the procedures described below in the Section titled "What is the process for making a claim under this Limited Warranty?" (the "Warranty Procedures"), purchase a replacement part, which may require additional fees for shipping and handling as applicable, return the allegedly defective Part to Sol Boards, and request a refund. Alternatively, Sol Boards may, in its sole and exclusive discretion, permit or require the Purchaser to return the allegedly defective Part or GolfBoard to Sol Boards in accordance with the Warranty Procedures, without requiring the Purchaser to first purchase a replacement part. In either situation, on receipt of the Part or the GolfBoard, Sol Boards will examine it to determine whether any problem identified by the Purchaser is covered under this Limited Warranty. If, following receipt of the Part or GolfBoard, Sol Boards determines that the Part or GolfBoard is not covered

by this Limited Warranty, Sol Boards will notify the Purchaser of its determination and may inform the Purchaser regarding service alternatives that may be available on a fee basis for both labor and replacement parts. If Sol Boards determines that the GolfBoard or Part is covered under this Limited Warranty, Sol Boards will, at its sole option, provide one of the following two remedies:

1. **Issue a refund** of the amount paid by the Purchaser for the replacement part(s).
2. **Replace the Part** with the same or reasonably equivalent part(s).

Any such refunds will be in an amount determined by Sol Boards in its sole discretion to reimburse the Purchaser a reasonable amount for the cost of the replacement part. The refund will not reimburse the Purchaser for any other fees or expenses incurred by the Purchaser, including, without limitation, any fees for shipping or handling of any replacement part.

The Purchaser, at the Purchaser's expense, shall be responsible for installing any such replacement part, and will be responsible for following the service guidelines and tutorials provided by Sol Board's Technical Support Team, and/or on-line via the GolfBoard maintenance videos available at GolfBoard.com. End users will be given exclusive password-protected access at the time of purchase. If Purchasers chooses to use a Sol Boards representative to replace a part or component (or third party designated by Sol Boards), the cost of any labor will be at the Purchaser's expense, payable to Sol Boards.

What are the shipping requirements?

The Purchaser will be responsible for all shipping and other costs of sending the GolfBoard and / or any Part(s) to Sol Boards and for all shipping and other costs of returning the GolfBoard and any Part(s) to the Purchaser (even if Sol Boards determines the GolfBoard or Part is covered under its Limited Warranty). If Sol Boards replaces a GolfBoard or Part, or issues a refund with respect to a Part or GolfBoard, Sol Boards shall have the option of taking ownership of the GolfBoard and any Part(s) that was replaced or for which Sol Boards issued a refund.

The GolfBoard contains a high-powered Lithium battery which is deemed a hazardous material, and as such, shipping the GolfBoard's battery requires compliance with, as applicable, numerous U.S., foreign and international laws and regulations, including, without limitation, specific labeling, packaging, and other shipping requirements, as well as requirements to ship batteries only via contract hazardous materials shippers. The Purchaser is solely responsible for shipping the GolfBoard's battery in full compliance with any and all applicable hazardous materials legal and regulatory requirements (domestic, foreign and international, as applicable), whether the battery is shipped separately or is shipped installed in the GolfBoard, including, without limitation, shipping via a contract hazardous materials shipper.

What are lithium battery special considerations?

The lithium battery in the GolfBoard must be properly maintained. Proper maintenance includes, without limitation, charging the battery after each use, and "cycling" the battery every two (2) months (see GolfBoard owner's manual winter guidelines). The battery requires specific storage and maintenance procedures during extended periods of inactivity. Specifically, the battery must be stored in a cool and dry location that is above 32 degrees Fahrenheit, and never allowed to fully discharge. Therefore, the GolfBoard's battery must be fully charged prior to storage, and fully recharged at least every 60 days. **Any failure to store the battery and / or GolfBoard in the proper environment, or letting the battery fully discharge, will nullify this Limited Warranty.**

What is the necessary maintenance?

Routine maintenance of the GolfBoard is required. The Purchaser is responsible for following all maintenance programs, procedures, and schedules in the most current version of the GolfBoard Owner's Manual available at the GolfBoard website (GolfBoard.com), which may be updated from time to time as Sol GolfBoard deems necessary or appropriate, and any other maintenance requirements applicable to the GolfBoard. Air pressure in tires should be periodically checked and maintained. **Any failure by the Purchaser to ensure that the GolfBoard receives reasonable and necessary maintenance will nullify this Limited Warranty.**

It is the responsibility of the Purchaser to routinely inspect the GolfBoard prior to every use and ensure the GolfBoard has no loose bolts, screws, fasteners, or fittings, which the vibration caused during normal use will or may loosen over time. For example, the fittings that hold the GolfBoard's stability bar in position must be routinely checked and tightened from time to time. Failure to do so will or may result in the stability bar becoming loose, which can damage the GolfBoard, including the component holder tray, the stability bar, stability bar mounting bracket, or other parts. Repair of any such damage shall be at the exclusive expense of the Purchaser.

The GolfBoard must be cleaned using only non-corrosive biodegradable cleaners, and should be hand cleaned with a damp rag. The GolfBoard undercarriage should be cleaned using compressed air. While the GolfBoard is water resistant, the GolfBoard is not water proof, and must not be pressure washed or subject to hosing with open water. The GolfBoard must not be operated in large puddles, water hazards, heavy rain or similar wet environments. **Failure to clean the GolfBoard according to Sol Boards requirements, or exposing the GolfBoard to wet environments will nullify this Limited Warranty.**

Is Sol Boards responsible for damage during shipping?

No. Sol Boards is not responsible for any loss or damage to the GolfBoard, any Part, or any replacement GolfBoard or Part, during shipment to or from Sol Boards. The Purchaser assumes all risk of loss and damage during shipment.

What is the process for making a claim under this Limited Warranty?

To make a claim under this Limited Warranty, the Purchaser must first call Sol Boards' toll-free customer support line (888) 328-2841 to speak with a Sol Boards customer support representative. Sol Boards may require that the Purchaser provide photographs, images, or other information regarding the problem or defect. Sol Boards' customer support representative will, for problems that cannot otherwise be resolved, provide directions to the Purchaser on how to purchase a replacement part and / or send Sol Boards (i) the GolfBoard or allegedly defective Part, and (ii) any additional information required or requested by Sol Boards. Following receipt of the GolfBoard or Part, Sol Boards will determine whether this Limited Warranty applies, and if it does apply, repair the Part, replace the Part, or issue a refund as set forth above in this Limited Warranty. The Purchaser is responsible for returning the GolfBoard, any Part(s) and any other items sent by the Purchaser to Sol Boards in suitable packaging, prepaying shipping and return charges and insuring all shipments (the Purchaser assumes all risk of loss and damage during shipment).

What must the Purchaser do in order for the Limited Warranty to be effective?

In order for the Limited Warranty to be effective, the Purchaser (or the Purchaser's lessee, if applicable) must, **prior to shipping of the GolfBoard(s) from Sol Boards**, fill out and return the warranty acceptance and registration card attached below, together with a copy of the Purchaser's receipt, to Sol Boards at the following address:

Sol GolfBoards, Inc.
61239 Tetherow Drive, #211
Bend, Oregon 97702

Are there any limitations on Sol Boards' liability?

Yes, the Purchaser's remedies are limited to those remedies specified in this Limited Warranty. Sol Boards' liability is further limited as follows:

TO THE MAXIMUM EXTENT PERMITTED BY APPLICABLE LAW, SOL BOARDS SHALL HAVE NO LIABILITY TO THE PURCHASER UNDER ANY CAUSE OF ACTION, WHETHER IN CONTRACT, TORT OR OTHERWISE, FOR ANY INDIRECT, SPECIAL, INCIDENTAL, CONSEQUENTIAL, OR PUNITIVE DAMAGES, OR FOR ANY LOST INCOME, LOST PROFITS, INCONVENIENCE OR FINANCIAL LOSS, ARISING FROM THE GOLFBOARD OR ITS SALE OR USE, EVEN IF SOL BOARDS HAS BEEN ADVISED OF THE POSSIBILITY OF SUCH LOSS(ES) OR DAMAGE(S), AND UNDER NO CIRCUMSTANCES SHALL SOL BOARDS' AGGREGATE MONETARY LIABILITY RELATING TO OR RESULTING FROM THE GOLFBOARD OR ITS SALE OR USE EXCEED THE LESSER OF (I) THE AMOUNT OF THE ORIGINAL PURCHASE PRICE

FOR THE GOLFBOARD ACTUALLY PAID BY THE ORIGINAL PURCHASER; OR (II) THE AMOUNT PAID FOR THE GOLFBOARD BY A SUBSEQUENT PURCHASER. THE REMEDIES OF REPLACEMENT OR REPAIR OF THE DEFECTIVE GOLFBOARD OR PART, OR A REFUND, ALL AS SET FORTH ABOVE IN THIS LIMITED WARRANTY, ARE THE SOLE AND EXCLUSIVE REMEDIES OF PURCHASER. SOL BOARDS' PRICE FOR THE GOLFBOARD AND ITS OBLIGATIONS UNDER THIS LIMITED WARRANTY ARE CONSIDERATION FOR LIMITING SOL GOLFBOARDS' LIABILITY.

THE REMEDIES PROVIDED UNDER THIS LIMITED WARRANTY ARE EXCLUSIVE AND DISPLACE ANY OTHER WARRANTIES OR REMEDIES. TO THE MAXIMUM EXTENT PERMITTED BY APPLICABLE LAW, SOL BOARDS (I) MAKES NO WARRANTIES OF ANY KIND EXCEPT FOR THOSE EXPRESSLY STATED IN THIS LIMITED WARRANTY; & (II) EXPRESSLY DISCLAIMS ALL OTHER WARRANTIES, EXPRESS AND IMPLIED, INCLUDING WITHOUT LIMITATION THE IMPLIED WARRANTIES OF MERCHANTABILITY AND FITNESS FOR A PARTICULAR PURPOSE, EXCEPT ONLY TO THE EXTENT SUCH IMPLIED WARRANTIES MAY NOT BE DISCLAIMED UNDER THE APPLICABLE LAW. ANY IMPLIED WARRANTIES THAT MAY NOT BE DISCLAIMED UNDER THE APPLICABLE LAW ARE HEREBY LIMITED, TO THE MAXIMUM EXTENT PERMITTED BY SUCH LAW, TO THE WARRANTY PERIOD OR THE MINIMUM DURATION OF SUCH IMPLIED WARRANTIES UNDER THE APPLICABLE LAW, WHICHEVER IS SHORTER, & THE REMEDIES PROVIDED UNDER THIS LIMITED WARRANTY SHALL BE THE EXCLUSIVE REMEDIES AVAILABLE FOR BREACH OF ANY SUCH IMPLIED WARRANTIES.

Can Sol Boards' employees or dealers modify this Limited Warranty?

No. None of Sol Boards employees, representatives, dealers, distributors, nor any other person, has the authority to make or imply any warranty, representation, promise, or agreement that varies from the terms of this Limited Warranty.

How does state or other law relate to this Limited Warranty?

This Limited Warranty gives you specific legal rights, and you may also have other rights which vary from State to State or Province to Province. Some States or Provinces do not allow the exclusion or limitation of incidental or consequential damages, so the above limitations or exclusions may not apply to you. Some States or Provinces do not allow limitations on how long an implied warranty lasts, so the above limitations or exclusions may not apply to you.

Other Limited Warranty Provisions

This Limited Warranty constitutes the entire statement of warranty regarding the GolfBoard. If a provision of this Limited Warranty is determined to be unenforceable in any respect, the enforceability of the provision in any other respect and of the remaining provisions of this Limited Warranty shall not be impaired.

This Limited Warranty: (i) is intended to comply with the terms of the Magnuson-Moss Warranty Act (the "Act") to the extent this Limited Warranty is subject to the Act; & (ii) shall be governed by the laws of the State of Oregon, USA, without giving effect to any conflict-of-law principle that would result in the laws of any other jurisdiction governing this Limited Warranty.

Unless prohibited by applicable law, any action, suit, or proceeding arising out of this Limited Warranty or its subject matter shall be litigated in Deschutes County, Oregon, USA.

Sol Boards thanks you for purchasing your GolfBoard. We hope it will give you years of enjoyment.

GOLFBOARD LIMITED PARTS WARRANTY ACCEPTANCE AND REGISTRATION

By way of their signature(s) below, Purchaser is agreeing to and accepting the terms set forth in the "GolfBoard Limited Parts Warranty (United States & Canada) document.

The Purchaser's Signature: _____

The Purchaser's Name: _____

The Purchaser's Address: _____

Product Purchased: _____

Extended Warranty Purchased: Yes No (Circle one)

Product Purchased From: _____

Date of Purchase: _____

Today's Date: _____

Please complete this Warranty Acceptance and Registration form, and return it to:

Sol Boards, Inc.
61239 Tetherow Drive, Suite 211 Bend, Oregon 97702

Or

Send an email to warranty@golfboard.com with the attached form as a PDF.



6. Appendix

6.1. GOLFBOARD OWNER ON-BOARDING PROCEDURES

OVERVIEW

Playing golf with a GolfBoard is new, fun and easy. With some simple instructions most anyone can quickly learn how to properly operate a GolfBoard. To ensure all owners have a safe and enjoyable experience, we have developed a comprehensive step-by-step overview of recommended On-Boarding procedures.

These On-Boarding procedures are easy to follow, but very important. Anyone owning a GolfBoard for the first time will need to implement the following procedures to ensure a safe and positive GolfBoarding experience.

NOTICE

All new GolfBoard users must watch the GolfBoard Safety Video prior to your first use, which can be found here: <https://www.youtube.com/watch?v=sSj8hybMGs>

In addition to watching the safety video, new user's must also accept all terms of the Company's liability waiver and release, and must to print and sign the liability waiver, which is available at [HERE](#).

NOTICE

If you need a copy of the Company's liability waiver and release please contact GolfBoard at 1-888-328-2841

Some golf clubs may also choose to have a specific liability waiver which is unique for their property. The Golfer will need to inquire as such, and then they must print and provide an executed copy of the Club's liability waiver and release to the club prior to using a GolfBoard on their property.

LEARNING PROCESS

The best place to learn how to operate your GolfBoard is in an open, flat, grassy area, with no obstacles or pedestrian traffic.

6.1.1. Controller Overview

The first step to learning proper GolfBoard usage is to properly learn how to use the thumb throttle mechanism. This includes familiarizing yourself with the on/off, hi/lo (5 and 10 mph max speed options), and forward/reverse switches. Be sure to always engage the

throttle gradually to accelerate. Do not fully depress the trigger suddenly or all at once, but always slowly accelerate by gradually depressing the trigger.



The GolfBoard does not have a separate braking mechanism, and simply releasing the trigger stops the board. Depending on speed, the board generally takes approximately 3 seconds or slightly less than 20 feet to come to complete stop. So it is important to always look ahead, and operate the board a safe distance from all obstructions, people, golf carts and other GolfBoarders. Always remember, just like a golf cart, a GolfBoard needs up to 30 feet to come to a complete stop when traveling at full speed, so maintaining an appropriately safe distance from all objects is critical to safe use. As such, when operating the board near other people or fixed objects, it is important to proceed with caution.

Once stopped, a rear parking brake will engage and the GolfBoard will not move until you engage the throttle again. As a general rule, it is best to stop the board on a flat, open area. If on steep terrain, the board should be parked sideways to the fall line in order to ensure the board does not move.

It is highly recommended that you operate your GolfBoard in the 'low' setting during the first few holes until you become proficient at accelerating gradually, turning, and stopping quickly.

6.1.2. Stability-Bar Instruction



The GolfBoard stability bar is an important safety feature for all new users. When in use, it is very important to ensure that the bag stand is securely mounted. Proper attachment methods are outlined in the **2.18.4 Attaching Your Golf Bag** section of the owner's manual.

To ensure maximum stability, you should firmly hold the stability bar at all times while the board is moving. The stability-bar assists with staying properly balanced, as well as greatly assists in steering the board.

Firmly gripping the stability bar is particularly necessary when accelerating and decelerating. Additionally, by applying pressure to the stability bar to the right or left, the board will turn more easily.

The stability-bar is also used to secure your golf bag. In addition to the standard strap found on most golf carts, the GolfBoard employs an additional strap near the bottom of the golf bag for added safety and security. It is important to make sure that tie-down straps are securely in place prior to operating the GolfBoard in order to avoid the bag and clubs falling in front of the board.

6.1.3. Proper Stance

The proper stance for GolfBoarding is very intuitive. You should stand in the traditional “surfers stance,” which is sideways on the board with feet shoulder width apart. Additionally, feet should be slightly staggered, with the toes of the front foot on one edge, and the heel of the other foot on the opposite edge. This surfer stance with a slight staggered foot position provides the greatest amount of stability and leverage to steer the board.



Shift your body weight from one side of the board to the other in order to turn. As weight is increasingly applied to one edge of the board, the wheels pivot causing the board to turn. The stability bar can also be pushed or pulled right or left to enhance turning ability. However, you should primarily use the shifting of your weight from toes to heels as the principal way to steer a GolfBoard.

The GolfBoard has a variety of proprietary features to ensure ease of use and safety, including quick deceleration whenever the remote trigger is released, as well as a remote on/off switch. You can quickly stop the board at any time by simply releasing the remote or thumb throttle trigger, or turning off the remote. Additionally, the remote has a reverse switch, which when depressed while moving forward will cause the board to decelerate, come to a stop, and then eventually begin to reverse direction.

6.1.4. First Use

Before turning on the GolfBoard, ensure the accelerator trigger is functioning without obstruction and moves smoothly.

After switching on the GolfBoard with the directional switch in the neutral position, you should get on the board and assume the proper stance. Next, firmly grip the stability bar with your forward hand. Finally, slowly depress the controller trigger on the thumb throttle mechanism, and gradually move the board forward. To turn the board, simply shift your body weight from side to side.

You should also learn how the board works in reverse. First, switch your stance so you are facing away from the stability bar. Next, hold the stability bar with your back hand. Then flip the thumb throttle direction control to reverse. Finally, slowly accelerate and demonstrate how the board turns right and left by switching your weight from side to side, in the same exact way as when going forward.

It is necessary to learn and practice reverse operation in order for you to back away from obstacles, tee-boxes, and putting greens, as well as manipulate the board around trees and other tight areas. Because the board turns in reverse using the exact same body weight movement as when in forward, reverse operation is largely intuitive once you have perfected forward operation.

6.1.5. New User Practice

Once generally familiar with the GolfBoard and its remote, you should briefly practice on a flat, open and grassy area, which is away from other people.

Before getting on the board, we recommend you practice moving the board slowly while walking along side it by controlling the trigger on the thumb throttle. Slowly depress the trigger just slightly to move the board ahead just a few feet.

Note: While it is a good practice to learn to slowly move the board forward before stepping on it, the GolfBoard is intended to be operated while standing on it. Other than testing the board prior to operation, you should be not depress the trigger unless standing on the board and holding the stability bar firmly.

Once you have perfected moving the board slowly forward, get on the board in a proper surfer stance. Then while stationary, hold the stability bar and practice leaning your bodyweight from side to side. Once you feel comfortable controlling the board and shifting your bodyweight to turn, it's time to head out! Remember to press the accelerator very slowly.

Because it takes a few minutes for most first time users to perfect the basic GolfBoarding skills, your practice session is best conducted in a wide open, flat and grassy area, with no other people nearby. Most new users quickly learn how to operate the GolfBoard, and feel very comfortable in just a few minutes of practice.

6.1.6. Safety & Operational Overview

GolfBoarding can be the most exciting way to enjoy golf on any course. You will quickly find that riding a GolfBoard is as much fun as golf itself. Surfing the fairway from shot to shot gives you a whole new way to enjoy the game. However, it is important to always make safety the top priority, as well as be sensitive to not disrupt the enjoyment of other golfers.

You should always remember to stay at least 30 feet from other GolfBoarders and golf carts when in motion. You may slowly approach a tee box or green where other golfers may be present, but you should never be closer than 30 feet behind another moving GolfBoard or golf cart.

While a GolfBoard is more environmentally friendly than a golf cart, it still should not be used on the greens, tees, bunkers, or out of bounds areas or hazards. GolfBoarders are expected to obey the same rules as carts, unless informed separately by the Club.

The GolfBoard is a low speed motorized vehicle, and the user needs to operate it with the same attention to safety as a golf cart or any motorized vehicle. As such, there are certain safe operating procedures which all GolfBoard users need to follow:

- Always stay a safe distance away from other people
- Look ahead, anticipate, and plan a safe route
- Accelerate slowly
- Be conscious to stay at least 30 feet from golf carts and other GolfBoards
- Remain in the low speed setting until fully comfortable with board operation
- Be courteous of all other golfers and follow standard golf etiquette



Congratulations on your purchase!

As the President of GolfBoard, I would like to take a moment to personally welcome you to the GolfBoard family. You have joined a movement that we believe is going to change the game of golf forever. The company was founded by a small group of fitness and boarding enthusiasts who created a product that people simply love to ride, and it has become our mission to engage as many golfers as possible in "Surfing The Earth."

GolfBoard reduces the amount of time it takes to play a round of golf, and perhaps most importantly, it all but assures you'll have a fun and enjoyable experience every time you play - regardless of what you shoot.

So go! Play! Be a kid again! And know that as you do, there's a company dedicated to supporting and continually enhancing your GolfBoarding experience for many years to come.

Enjoy,

Jeff Dowell
President
GolfBoard Inc

